

Original declaration of incorporation with manual for **ARIS Actuator ExTensor**

Actuator for potentially explosive atmospheres of zone 1



Table of content

1. Identification	3
1.1 Approvals / Labeling	3
1.2 Nameplate / Labeling	3
1.3 Guidelines and standards	4
2. Safety information	4
2.1 Warnings	4
2.2 General safety advice	5
3. Technical specification	5
3.1 Functions and application areas (Intended use)	5
3.2 Housing entries (tapped holes)	6
3.3 Performance data	7
3.4 Dimensions	8
4. Actuator setup for utilization	12
4.1 Transport, (temporary) storage and downtimes	12
4.2 Packaging	12
4.3 Safe disposal of packaging	12
4.4 Installation and mounting	12
4.5 Information about coatings	13
5. Initial operation	14
5.1 Opening the actuator	14
5.2 Electrical connection	15
6. Actuator operation without modules (Standard)	18
6.1 Operation	18
7. Options	36
8. Maintenance and service	36
9. Declaration of incorporation	37
10. Type examination certificate	38

1. Identification

This manual is valid for:

Description: Electrical actuator for potentially explosive atmospheres ATEX / IECEx
Type: ExTensor (and add-ons/options)
Further details see chapter 1.2 nameplate / labeling

1.1 Approvals / Labeling

ATEX (Gas)

 II 2 G Ex db IIC T6 Gb

ATEX (Dust)

 II 2 D Ex tb IIIC T80°C Db

IECEX

 IECEX IBE 22.0020X

EU type examination certificate no. IBExU22ATEX1066 X

Type of construction: Flameproof enclosure

1.2 Nameplate / Labeling

The actuators hold two nameplates. They are located on the outside of the actuator.

Plate 1: Metal nameplate with all details for ATEX / IECEx; plate 2: Label with actuator specific data

Metal nameplate ATEX / IECEx details

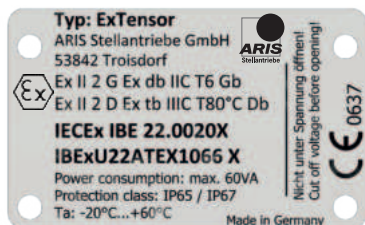

Description:

Actuator type
Manufacturer information
Ignition protection type
IECEX number
Number of licensing office
Power rating
IP protection class
Ambient temperature

Label with actuator specific data

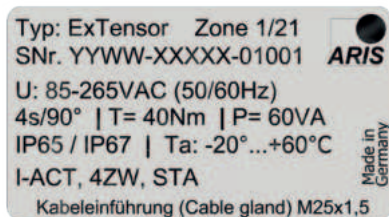

Description:

Actuator type
Serial number (YYWW=Construction year+week)
Power rating
IP protection class / Ambient temperature
Equipment features / Options

(Plate and label exemplary)

1.3 Guidelines and standards

Aris actuators of the ExTensor series are partly completed machinery in the sense of the European Directive 2006/42/EC. The Declaration of Incorporation for the devices can be found at the end of this operating manual. During the development, production and operation of the devices, compliance with the essential health and safety requirements is ensured through conformity with the following standards

EN IEC 60079-0:2018

EN 60079-1:2014

EN 60079-31:2014

This compliance is confirmed by the EU type examination certificate IBEXU22ATEX1066X. The complete explosion protection marking reads:

II 2G Ex db IIC T6 Gb
II 2D Ex tb IIIC T80°C Db
Ta -20°C...+60°C

The suitability of the quality assurance system of the company "Aris Stellantriebe GmbH" required for the production of the actuators according to Directive 2014/34/EU is proven by notification number

IBExU23ATEXQ013.

The suitability of the quality assurance system of the company "Aris Stellantriebe GmbH" required for the production of the actuators within the scope of the "IEC CERTIFICATION SCHEME FOR EXPLOSIVE ATMOSPHERES" is proven by Report-no.





EN/IBE/QAR23.0002/00

IB-23-6-0037

2. Safety information

2.1 Warnings

Installation and initial operation only by certified experts according to this manual. Observe the significance of the following symbol and note explanations. They are subdivided in security levels and classified according to ISO 3864-2.

 DANGER	DANGER indicates a hazard with a high risk degree, which, if not avoided, causes death or heavy injuries.
 WARNING	WARNING indicates a hazard with a medium risk degree, which, if not avoided, can cause death or heavy injuries.
 CAUTION	CAUTION indicates a hazard with a low risk degree, which, if not avoided, can cause slight or moderate injuries.
 ADVICE	Indicates general advice, useful hints and work recommendations, which don't have influence on the safety and health of the staff.

2.2 General safety advice



- This manual has to be kept at the operating site at any time.
- Read the manual carefully prior to installation and initial operation.



While operating electronic devices certain parts are obligatory under hazardous voltage.

The manufacturer reserves the right to make technical changes and improvements at any time.

3. Technical specification

3.1 Functions and application areas (Intended use)

ARIS actuators of the ExTensor series are designed exclusively for industrial use in potentially explosive areas according to their labeling. They are used to actuate control and shut-off devices (flaps, valves, taps, sliders, dosing pumps, etc.).

ARIS actuators may not be used for

- in continuous underwater use (observe protection class)
- in hazardous areas of zones 0 and 20
- in Group I hazardous areas (mining)
- in radiation-exposed areas in nuclear plants
- at temperatures below -20 °C or above $+60\text{ °C}$
- underground
- near open fires

ARIS Stellantriebe GmbH assumes no liability for any production errors and the resulting damage or consequential damage after the drive has been checked, installed and declared functional.

In particular, ARIS Stellantriebe GmbH assumes no liability for any production errors and the resulting damage or consequential damage in the event of improper use of the drive, if the drive has not been adequately tested within an overall system, or if errors are found during an initial or further test and the drive is not was immediately taken out of service.

3.1.1 *Special conditions for safe use of the actuator in hazardous areas* (Acc. point 17, EC type examination certificate)

- The actuator can be used in an extended ambient temperature range from -20 °C to $+60\text{ °C}$.
- Repairs to the flameproof gaps may only be carried out in accordance with the manufacturer's design specifications. Repairs according to the values in Tables 2 and 3 of EN 60079-1 are not permitted.
- Only the screw plugs specified by the manufacturer (strength class at least A2-70 according to ISO 4762) may be used.
- The cable and line entries used must be suitable for a maximum operating temperature of at least 80 °C . All openings that are not required for the introduction of cables and lines must be permanently closed with suitable sealing elements that have been confirmed for explosion protection according to EN 60079-1 for group IIC or according to EN 60079-31 for group IIIC.

3.1.2 Overview

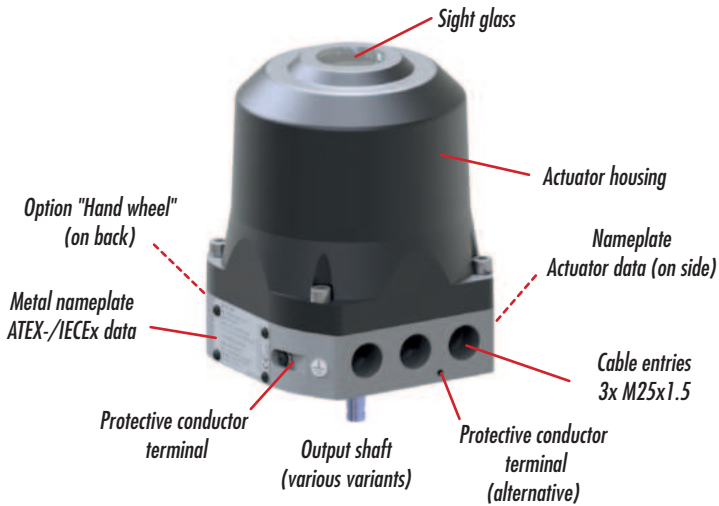

3.2 Housing entries (tapped holes)

3.2.1 Cable and wire entries

Features **ARIS ExTensor**
3x M25x1.5 tapped holes

When delivered, the actuators are provided with a transport protection (protective sticker), which covers the threaded holes of the cable and line entries. This must be removed and replaced with suitable, approved entries or plugs. The entries/blind plugs used must correspond to the ignition protection types of the drive. In addition, these must meet the IP protection class - at least IP65 and IP67.



DANGER! Operation with the sticker or parts thereof is not permitted. Non-compliance can lead to serious accidents and property damage - The ATEX/IECEX approval of the device becomes void in the event of non-compliance or misuse.

Only suitable cable and line entries and blind plugs certified according to the ATEX/IECEx protection class may be used for the introduction of cables (lines) - the diameters must correspond to the cables used.

Unused housing entries (threaded holes) which are intended for the use of cable and line entries must be sealed with suitable blind plugs certified according to the ATEX/IECEx protection class. When selecting the correct cable and line entry, EN IEC 60079-14 must also be observed. The cable and line entries as well as blind plugs must be suitable for an operating temperature of at least +80°C.

 WARNING	<p>DANGER! On the back of the drive, there is a blind plug to close the handwheel option for equipment variants without a handwheel. This may not be removed or altered. See also Chapter 6 - Handwheel section.</p>
	<p>Another transport protection sticker is located on top of the drive hood to protect the sight glass during transport / storage. This must also be removed prior to commissioning. Operation with the sticker or parts thereof is not permitted. Non-compliance can lead to serious accidents and damage to property - The ATEX/IECEx approval of the device becomes void in the event of non-compliance or misuse.</p>

Suitable products (cable entries, blind plugs) are available as accessories from ARIS, tailored to the ATEX/IECEx products. If required, these are loosely enclosed with the drive. The delivery is always unassembled.

Please note the correct assembly. The cable entries used must always be designed for the connecting cables and correspond to the cable diameters.

3.3 Performance data

<i>Voltage supply AC</i>	85...265 V AC (50/60 Hz)	<i>End position cutoff</i>	Digital
<i>Voltage supply DC</i>	24 V DC ($\pm 10\%$)	<i>Position feedback</i>	Digital, contactless
<i>Max. power consumption</i>	60 VA	<i>Connection</i>	Cable/wire entry: 3x M25x1.5
<i>Torque</i>	5 Nm...500 Nm	<i>Ambient temperature</i>	-20° C...+60° C
<i>Actuating time</i>	1s/90°...150s/90°	<i>IP protection class</i>	IP65/IP67
<i>Motor type</i>	BLDC		

 ADVICE	<p>ARIS actuators type ExTensor correspond in their basic form (primary version) up to 40Nm torque - without gear extensions, the EU type examination certificate number IBExU22A-TEX1066 X. - see appendix of these operating instructions. Variants with torques of 50 ... 500Nm (secondary versions) correspond to the primary version, but are supplemented by an externally mounted gear extension (planetary gear stage).</p>
---	---

3.4 Dimensions

ExTensor Model "S"
(Primary model)

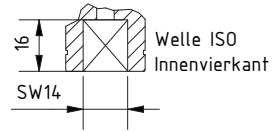
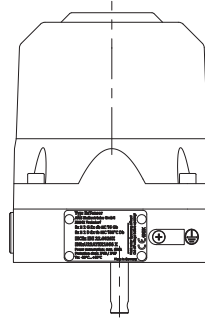
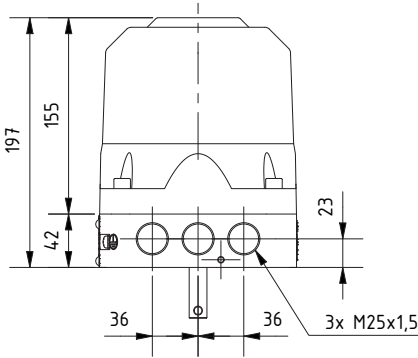
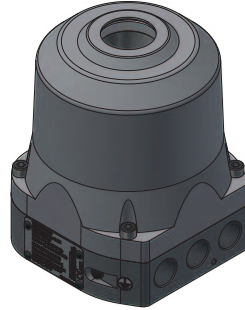
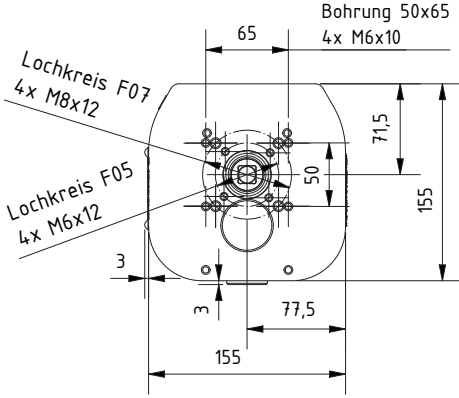

Wellen Passfeder

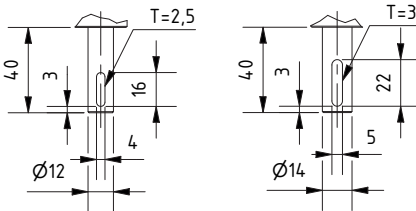

Wellen Querbohrung

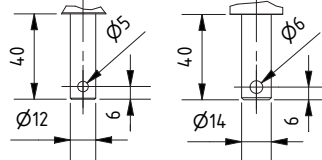

**ExTensor Model "M"
(Secondary model)**

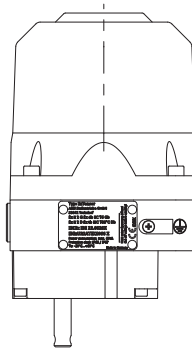
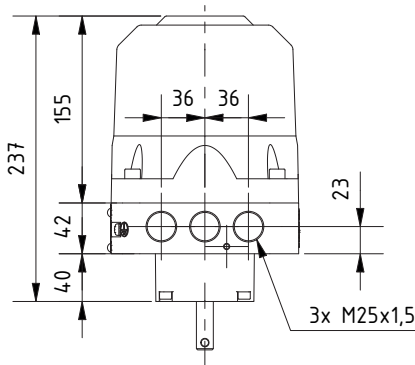
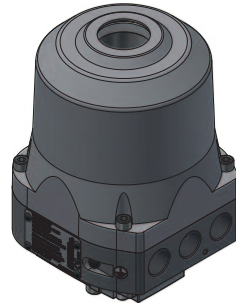
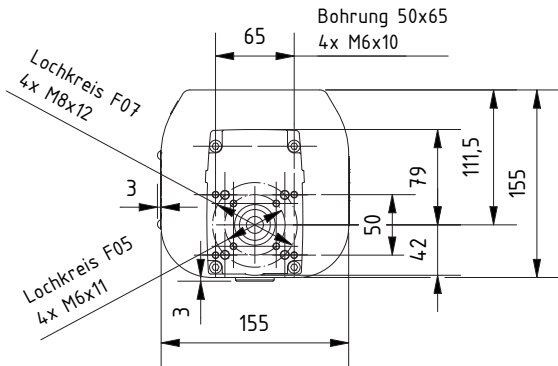

Welle
Passfeder

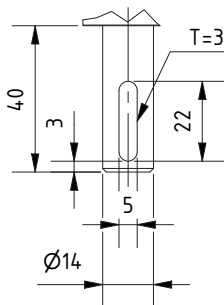

Welle
Querbohrung

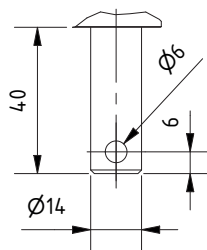

Welle ISO (5211)
Innenvierkant

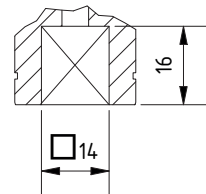

ExTensor Model"L"
(Secondary model)

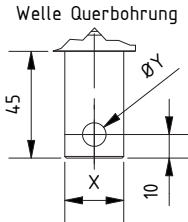
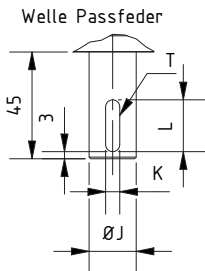
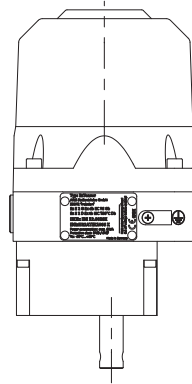
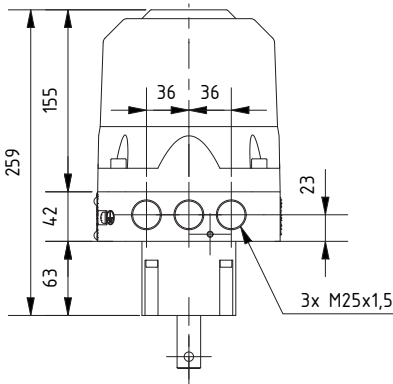
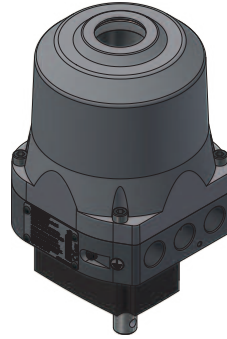
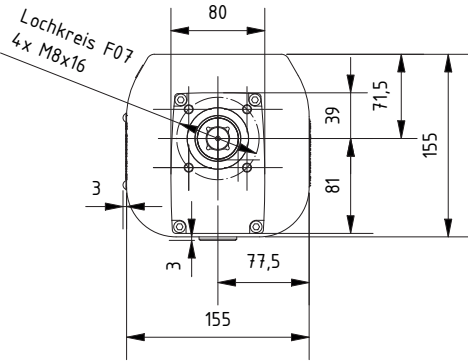

ISO-Welle Vierkantmaße		
Drehmoment	Maß A	Maß B
80-150	17	21
150-180	22	24

Welle Querbohrung		
Drehmoment	Maß ØX	Maß ØY
80-150	20	8
150-180	25	10

Welle ISO (5211)
Innenvierkant

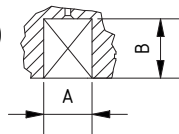

Wellen Passfeder				
Drehmoment	Maß ØJ	Maß K	Maß L	Maß T
80-150	20	6 P9	22	3,5
150-180	25	8 P9	32	4

*ExTensor Model "XL"
(Secondary model)*

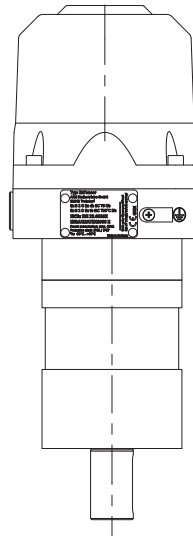
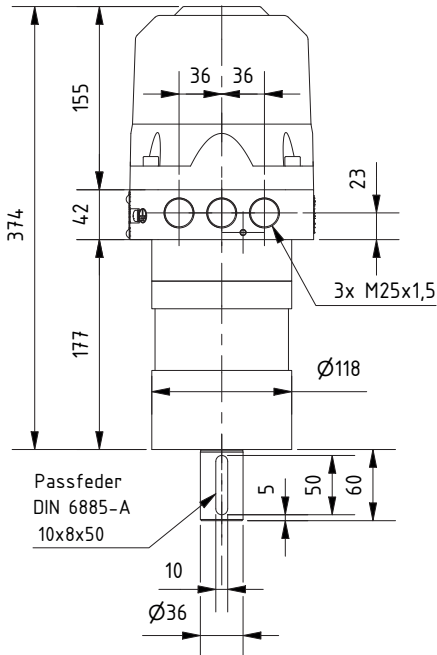
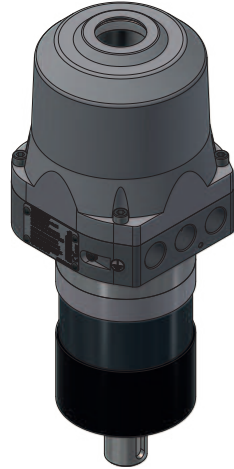
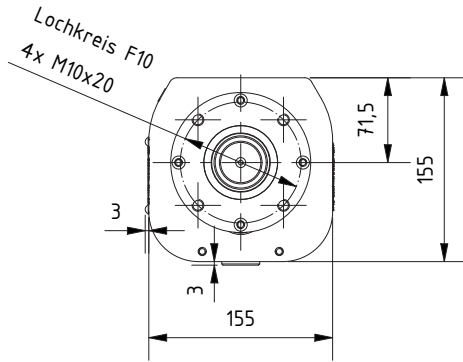

Welle ISO (5211)
Innenvierkant

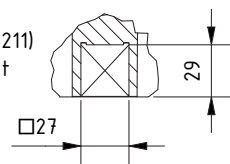

3.4.1 Weights

ExTensor "S"	6.5 kg
ExTensor "M"	7.5 kg
ExTensor "L"	8.5 kg
ExTensor "XL"	15.5 kg

Weights are approximate and may vary slightly depending on the equipment variant.

4. Actuator setup for utilization

4.1 Transport, (temporary) storage and downtimes

Use the factory packaging for transport to the installation point.
Replace a damaged original packaging by a new solid packaging.

- Actuator with attached valve: only attach lifting gear to the valve and NOT to the actuator
- ARIS actuators must not be used as a climbing or supporting aid
- ARIS actuators must not be operated in unsecured lifting mode without additional applications
- Storage in well-ventilated and dry rooms
- Protection against possible soil moisture (shelf storage)
- For longer storage times, moisture-absorbing agents should be placed in the drive
- The drives must be protected from dust and dirt
- Actions must be taken to avoid the formation of condensation (e.g. in the event of temperature fluctuations)

4.2 Packaging

ARIS drives are protected by special cardboard packaging for transport from the factory. Unpacking in the Ex area is not permitted as the materials could become electrostatically charged.

4.3 Safe disposal of packaging

Additionally necessary packaging is made by easily separable packaging materials and can be recycled individually:

- Wood
- Cardboard
- Paper
- Plastics

4.4 Installation and mounting

Installation, electrical connection, commissioning, operation and maintenance may only be carried out by trained specialist personnel who have been authorized by the system operator or system manufacturer.

Personnel requirements: National requirements, EN IEC 60079-14, EN IEC 60079-17, EN IEC 60079-19.

Before commissioning or working on this actuator, the personnel must have read and understood these instructions and also know and observe the applicable rules for occupational safety. Work in hazardous areas is subject to special conditions that must be observed. The plant manufacturer/operator is responsible for compliance and monitoring.

Prior to initial operation

- inspect drive for damage prior to installation
- the screw-in depth of the mounting screws must not be exceeded according to the information in the drawings
- before commissioning, check the tightness of the cable entries and blind plugs
- tighten the hood screws evenly (torque 12 Nm, also note the notes under point 5.1.1)
- protect the drive from the effects of the weather (e.g. with a protective roof)
- do not expose the drive to hard shocks (e.g. by dropping it); no ropes, hooks, etc. attach directly to the drive
- permanent overloading and blocking of the drive leads to damage to the drive
- only use original ARIS spare parts

Consider prior to attachment of couplings:

- Do not turn actuator shafts by force;
- actuator and valve shafts must run centric.

 WARNING	No additional holes may be drilled into the drive housing and the hood.
	Any modifications to the actuator are strictly prohibited and will result in the loss of the ATEX/IECEx protection approval.

4.5 Information about coatings

The actuator is delivered from the factory with either a painted or unpainted/bare cover.

Subsequent coating of the unpainted/bare cover is permitted if the requirements of EN IEC 60079-0:2018 Section 7.4 are met.

 WARNING	Deviations from the requirements of EN IEC 60079-0:2018 Section 7.4 are strictly prohibited and will result in loss of ATEX/IECEx protection approval.
--	--

 WARNING	The actuator cover or the anodized lower part of the housing that have already been painted must NOT be additionally coated!
--	--

5. Initial operation

 WARNING	Work on open live drives, e.g. setting the end positions, may only be carried out if the occurrence of an explosive atmosphere can be ruled out for the period of work.
	The actuator without the drive cover may only be operated for a short period of time for essential adjustment and commissioning processes.
	Dangerous voltage: Electric shock possible! <ul style="list-style-type: none">• The drive may only be commissioned by qualified personnel!• De-energize before opening the actuator.• For electrical installation and commissioning, the applicable regulations have to be observed.

5.1 Opening the actuator

 CAUTION	Do not disconnect under voltage!
--	----------------------------------

 WARNING	Before removing the drive cover, the drive must be switched off from the power supply.
	Installation and commissioning only by qualified specialists in accordance with the operating instructions.
	After loosening and removing the cover screws, carefully lift the drive cover off the lower part of the housing. Do not tilt or wobble. This can lead to irreparable damage to the flameproof gap.

Only the screws installed on the drive may be used to mount the cover. If lost, screws of the same standard, dimensions and strength must be used.

Screw type: ISO4762 - M8x40 - A2-70

The drive cover is screwed to the lower part of the housing with 4 screws (M8x40). The drive cover and housing base are assembled with each other via a narrow, cylindrical fit to form the "flash-proof gap".

Care must therefore be taken when lifting the drive cover so that the components do not tilt.

 CAUTION	When the cover hood is lifted, a vacuum can develop in the drive, which makes it difficult to lift the hood. This can be avoided by loosening a cable/line entry or blind plug so that air can flow through it. DANGER! The lead-in must be professionally closed again before commissioning or for further storage.
	Danger! Pressure proof encapsulation

To create the type of protection, flameproof gaps with narrow cylindrical fits are installed.
Gap surfaces must not be damaged. Damaged surfaces must not be machined or repaired in any other way - contact ARIS Service.
Cover and housing parts must be handled with care.
Avoid tilting the components during assembly.

5.1.1 Closing the actuator

After the adjustments have been made, the drive cover must be reassembled.

Note the following points:

- The cleavage surfaces must be clean and free from contamination or damage
- The sealing surfaces must be clean and free from contamination or damage
- Check the seat of the seal (O-ring) on the lower part of the housing and make sure that it is undamaged and free of dirt
- If necessary, apply an anti-corrosion agent (Vaseline (petrolatum) or soap-thickened mineral oil) to the cylinder surfaces of the gap
- Put the drive cover back on without tilting it

Note the mounting orientation based on the flange geometry. When the hood is put on, overpressure can occur inside the drive, which means that the hood can only be pushed open slowly. Proceed slowly and carefully so that the air can escape. This can be avoided by loosening a cable/line entry or blind plug so that air can escape and the overpressure can be reduced.



The lead-in must be professionally closed again before commissioning or for further storage.

Tighten the screws step by step in a cross pattern, observe the tightening torque.

Tightening torque cover screws: M8x40 A2-70 = 12Nm

5.2 Electrical connection

The electrical connection may only be carried out by qualified electricians.



Dangerous voltage: Electric shock possible!

- The drive may only be commissioned by qualified personnel (electricians)!
- De-energize before opening the actuator.
- The applicable regulations must be observed during electrical installation and commissioning.



Danger! Observe the regulations applicable to the hazardous area for handling electrical components in your operating environment.

To open the drive cover, proceed as described under 5.1.

The connection diagram in the drive is binding for the electrical connection. Note the voltage type!

Grounding

The drive must be provided with a protective conductor connection / grounding both inside and outside. The connection threads / positions are marked with the earth symbol 

Outer PA connection at least 4 mm².

Before switching on for the first time, check:

- Is the drive externally undamaged?
- Is the mechanical attachment O.K.?
- Has the electrical connection been made correctly?
- Check whether the type of current, mains voltage and frequency match the motor data (see rating plates on the hood and in the drive).
- Use cable glands suitable for the connecting cable.
- Be sure to observe the wiring diagram glued to the hood.
- For extra-low voltages (e.g. potentiometers), separate, possibly shielded cables should be used.

Temperature monitor

To protect against increased temperatures, the actuator is equipped with a manually resettable bimetallic temperature monitor on the inside. This is connected in front of the operating voltage supply.

At increased temperatures > +85°C in the drive, the temperature monitor switches off the supply voltage and thus the drive. This serves to comply with the type of protection, the temperature class and the fulfillment of the ATEX/IECEX standards.

After a cooling phase of approx. 30 minutes and a temperature reduction of at least 10K, the temperature monitor can be reset manually by pressing the actuating button (red).

In doing so, observe the procedure and instructions for opening and connecting the drive in these operating instructions. De-energize the drive before opening.

Make sure that there is no explosive atmosphere in the area when working on the drive.

Also, before performing a reset, make sure that the causes of the elevated temperature have been eliminated.

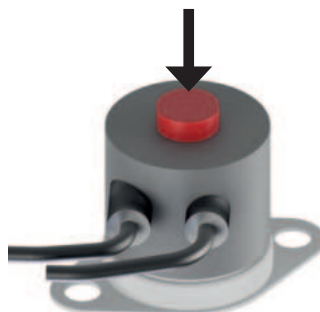

5.2.1 Wiring diagram

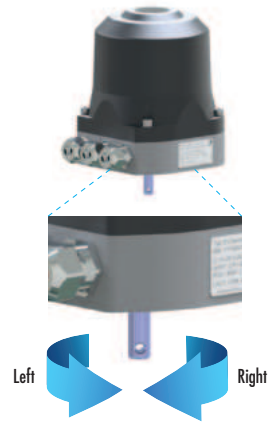
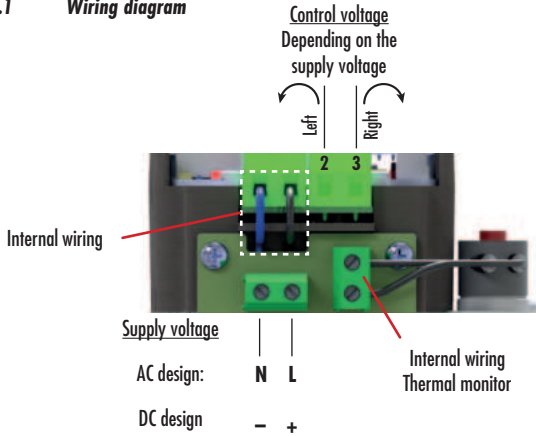

Connection 85...265 V AC

N	Neutral conductor
L	Phase / Supply 85 ... 265 V AC
2	Control connection > left-turning (CCW)
3	Control connection > right-turning (CW)

Ground wire inside of the housing.

Connection 24 V DC

-	GND
+	Connection 19.2...28.8 V DC
2	Control connection > left-turning (CCW)
3	Control connection > right-turning (CW)

6. Actuator operation without modules (Standard)

6.1 Operation

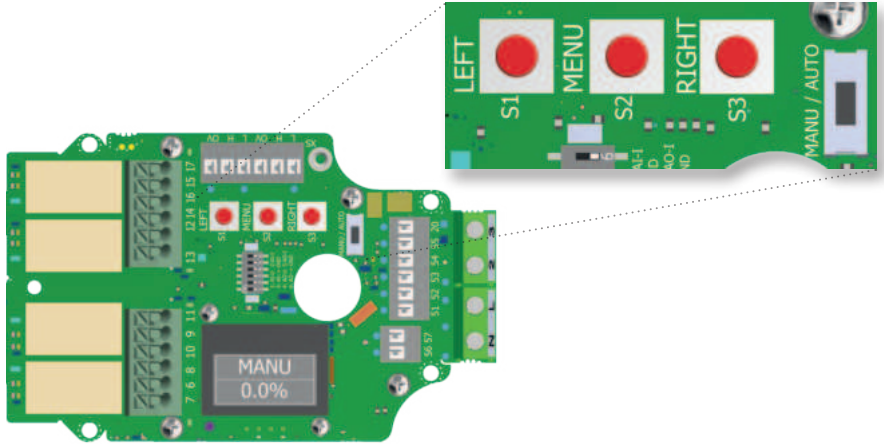

The Tensor² is operated via 3 buttons and a slide switch, located above the actuator's display. The OLED display makes setting up the actuator easier by showing text such as letters, numbers and signs.

Navigate between different menu items by using the buttons LEFT [L] & RIGHT [R].

6.1.1 Buttons and switches

The buttons (1) are indicated with

LEFT [L]

MENU [M]

RIGHT [R]

The functionality of the buttons is explained in section "Operating modes".

6.1.2 Operating modes

The different operating modes of the actuator can be selected via the slide switch resp. the MENU button. The actual operating mode is shown on the display.

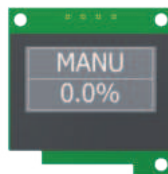

Automatic operation (AUTO mode, switch position "AUTO"):

The actuator runs with an external signal, which is present depending on the setting on the terminal clamps, the signal clamps or CAN clamps. The onboard buttons are without function.

Manual mode (MANU mode, switch position "MANU"):

The actuator can run left and right by using the buttons "L" & "R", if the actuator is not in setup mode. Change to setup mode by pressing the MENU button longer than >1s.

Setup mode (Switch position "MANU"):

Different actuator parameters can be set up and adjusted.

Start setup mode:

1. Slide switch to position "MANU"
2. Press button MENU longer than >1s

Setup mode is turned on and the first menu item "MAIN MENU" is displayed.

Within the setup menu navigate between different menu items and adjustments by pressing the buttons "L" & "R".

Confirm any entry by pressing the MENU button (press <0.5s).

Exit any menu item by pressing the MENU button longer than >1s.



Exit setup mode:

Exit the setup mode by moving the slide switch to position "AUTO" and confirming the notification message.

Alternatively press the MENU button in the top menu layer longer than >1s and confirm the notification message. The actuator then changes to manual mode (MANU mode).



ADVICE

A warning message is displayed when switching between different operating modes, because the actuator can run under certain conditions. Confirm the message with the MENU button.



WARNING

The actuator may run and move the connected valve when switching from MANU to AUTO and you confirm the warning message. After switching from MANU to AUTO and confirming the warning message the actuator can be operated by using the buttons "L" & "R".

6.1.3 Menu system overview

Menu items

Depending on the selected user, stored access authorisation, set parameters and the model type of the actuator, single menu items may be invisible/hidden differing from the following overview.

x = menu item visible

Menu	Sub item	Function	Standard	POTI (Potentiometer)	A-OUT (Analog output, Current/Voltage output)	CONTROL (Controller, i-Act)			
MAIN MENU		Main Menu	X						
	LOGIN	Login (Select user)							
	End positions	Set up end positions (Left & right)							
	Poti input	Settings for operating the actuator via external potentiometer							X
	Poti output	Settings for potentiometer output values (Feedback)					X		X
	Set value	Settings for set value defaults (Drive via set value)							X
	Actual value	Settings for actual value output (Feedback current/voltage)						X	X
	Relay switch	Programming relays behaviour (Option board)					visible only with attached relays module (Option board)		
EXPT. MENU		Expert Menu	X						
	Signal IN	Selection of input signal for driving the actuator							
	Signal OUT	Selection of output signal for position feedback							
	Wire monitor	Setting of actuator behaviour in case of cable breakage (formerly wire break monitoring)							X
	Status info	Activate/Deactivate message output					X	X	X
	Offset	Settings for allowed control deviation in controller mode			X				

	Hyst. Start	Define start hysteresis	X
	Hyst. Stop	Define stop hysteresis	
	Stall-det.	Settings for block detection	
	Block-det.	Settings for block detection near the end positions	
	RPM acc.	Define acceleration ramp of actuator	
	RPM red.	Define break ramp of actuator	
	Add feature	Entry of activation code for function extensions	
POWR. MENU		Power Menu	X
	Torque/Speed	Selection of a torque/time combination for CCW resp. CW rotation	
INFO MENU		Information Menu	X
	Firmware	Indicates firmware revision	
	Hardware	Indicates hardware revision	
	Serial-No.	Indicates serial number of the electronics	
	Features	Indicates unlocked actuator functions	
	On-time	Indicates operating hours of the actuator	
	Cycl. Count	Indicates number of starts of the actuator	
	Modules	Indicates connected modules/option boards	

Menu items in detail

MAIN MENU

Login	Enables selection of an access level. If a password has been stored, enter it here to proceed to further menu items. Depending on the selected access level, single menu items may not be visible or adjustable. If the login is missing, only the INFO MENU and the menu item LOGIN (in MAIN MENU) are visible.
	<p>The following users are selectable:</p> <ul style="list-style-type: none"> • User • Service • Manufacturer (ARIS only) <p>A logged in user can be logged out via the menu item "Logout".</p>

Login (Contd.)	<div style="background-color: #003366; color: white; padding: 5px; display: inline-block;">! ADVICE</div> <p>A user has to be selected/logged in on initial switch on or after a voltage loss, even if no password was given for the selected user. If no password was stored for the user, the password entry is skipped and the first menu item will be displayed.</p>
	<p>Password entry:</p> <ul style="list-style-type: none"> • Select the appropriate figure via buttons L & R (actual figure is flashing) • To edit the figure press the MENU button -> An underscore is shown below the figure. • Set selected figure by using buttons L & R. • Confirm the set figure with the MENU button. • Navigate to the confirmation arrow after password entry and confirm with the MENU button. <p>No error message is shown when entering a wrong password. A correct password or the active user is marked with an asterisk (*) behind the selected user. Example with user "User": Password correct/User active: > User* Password wrong/User inactive: > User</p>
End positions	<i>End positions</i>
	Selection and setting of the left (EL) and right (ER) end position.
	Approach end positions using buttons L and R and then store them.
	<p>Procedure:</p> <ul style="list-style-type: none"> • Select the end position to be set • Within the display "<EL>" or "<ER>" approach left resp. right end position via buttons L & R and confirm with MENU button • Accept (Y) or cancel (N) storing the end positions. Change between (Y)/(N) via buttons L & R, confirm selection with MENU button.
	<div style="background-color: #ffff00; padding: 5px; display: inline-block;">! CAUTION</div> <p>Motor or parts can be damaged when driving against obstacles. The motor does not stop at the prior set end positions during an end position is re-programmed. Drive the actuator slowly and carefully when setting new end positions.</p>
	<div style="background-color: #003366; color: white; padding: 5px; display: inline-block;">! ADVICE</div> <p>Left and right end positions can be interchanged. The assignment of the turning direction of the inputs 2/3 and the buttons LI/RE do not change.</p> <p>The end positions must be 28° apart due to technical reasons. If the difference range is too small, the actuator will prompt "Error Code 51".</p>

Poti Input	Actuator control via external potentiometer, only visible and adjustable with "Signal IN" = "Poti"
	<p>Matching of the set value signal for the left and right end positions for controlling the actuator via a potentiometer. This menu item can only be set, when "Poti" is selected under "Signal IN". The DIP switch must be set correctly on the board (see menu item "Signal IN").</p> <p>The connected potentiometer is supplied with 5 V DC via the electronics of the actuator.</p> <p>The set value signal of both end positions can be set as a percentage of the total voltage applied to the potentiometer. The following settings are possible for the left and right end positions: Set value signal = 0% 10% 90% 100% free (free values, selectable via display)</p>
Poti Output	Position feedback via potentiometer, only visible and adjustable with "Signal OUT" = "Poti"
	<p>Setting of the actual value signal at the output of the electrical potentiometers relating to the left and right end position.</p> <p>This menu item can only be set, when "Poti" is selected under "Signal OUT".</p> <p>The DIP switch must be set correctly on the board (see menu item "Signal OUT").</p> <p>The actual value signal of both end positions can be set as a percentage of the total voltage applied to the potentiometer.</p> <p>The following settings are possible for the left and right end positions: Actual value signal = 0% 10% 90% 100% free (free values, selectable via display)</p>
	<p>! ADVICE</p> <p>The terminal designation for the potentiometer output is differently to prior Tensor electronics. The original terminals 18 and 19 are replaced with terminals 54 and 55. Wiring diagram see description for "Signal OUT".</p>
	<p><u>Performance data for potentiometer</u></p> <p>Resolution: 12 bit</p> <p>Output impedance: 1 kΩ</p> <p>Supply voltage: 4.75...28.8 V DC</p>
Set Value	Settings for set value input when controlling with i-Act controller, only adjustable with "Signal IN" = "Ctrl. [mA]" or "Ctrl. [V]"
	<p>Matching the set value signal for the left and right end position.</p> <p>This menu item can only be set, when "Ctrl. [mA]" or "Ctrl. [V]" is selected under "Signal IN".</p> <p>The set value signal of both end positions can be set as follows: Set value signal current = 0 mA 4 mA 20 mA free (free values, selectable via display) Set value signal voltage = 0 V 2 V 10 V free (free values, selectable via display)</p>
	<p>! ADVICE</p> <p>For a proper function, the DIP switch near the buttons must be set equivalent to the settings in the menu! Setting the DIP switch see description for "Signal IN".</p> <p>NOTICE: Defaults for the set value of the end positions must cover min. 20% of the total range, otherwise "Error Code 80" will be displayed.</p> <p>Example: Signal range 4 mA => Coverage 4 mA x 20% = 0.8 mA Lower end position 0.1 mA => Upper end position min. 0.9 mA (= 0.1 mA + 0.8 mA)</p>

Set Value (Contd.)	<u>Performance data for set value input</u> Resolution: 12 bit Set value input: Current input 0...20 mA, Burden 50 Ω Voltage input 0...10 V DC, input impedance >200 kΩ
Actual Value	<i>Settings for actual value output as position feedback, only adjustable with "Signal OUT" = "Ctrl. [mA]" or "Ctrl. [V]"</i>
	Matching the actual value signal for the left and right end position. This menu item can only be set, when "Ctrl. [mA]" or "Ctrl. [V]" is selected under "Signal OUT". The actual value signal of both end positions can be set as follows: Set value signal current = 0mA 4 mA 20 mA free (free values, selectable via display) Set value signal voltage = 0 V 2 V 10 V free (free values, selectable via display)
	<div style="background-color: #003366; color: white; padding: 5px; display: inline-block;">! ADVICE</div> For a proper function, the DIP switch near the buttons must be set equivalent to the settings in the menu! Setting the DIP switch see description for "Signal OUT". NOTICE: Defaults for the set value of the end positions must cover min. 20% of the total range, otherwise "Error Code 70" will be displayed.
	<u>Performance data for actual value output</u> Resolution: 12 bit Actual value encoder: Magnetic position sensor Actual value output: Current output 0...20 mA, Burden 50 Ω Voltage output 0...10 V DC
Relay Switch	<i>Relay settings for options board with additional switches for position feedback, only adjustable in combination with mounted relay board</i>
	Behaviour setup for the bi-stable relays on the relay board. Up to 4 relays are available, depending on the chosen relay board. The switching state of the relays is retained even in currentless condition, so that the auxiliary switches can be used.
	<u>Performance data of relay (Add-on board)</u> Amount of relays: 2 (optional 4) Relays type: Bi-stable relay Switching voltage: max. 250 V AC / 125 V DC Allowed continuous current/channel: max. 2 A (at 230 V AC / 30 V DC); max. 0.2 A (at 125 V DC)

Relay Switch (Contd.)	<p>The following relay settings are available:</p> <ol style="list-style-type: none"> 1. "Off": Relays switched off/inactive 2. "Sw.pt.high" (Switch point high): Relay is switched on/active from right end position to the set switching point SP. Relay is switched off/inactive from left end position to the set switching point SP. 3. "Sw.pt.low" (Switch point low): Relay is switched off/inactive from right end position to the set switching point SP. Relay is switched on/active from left end position to the set switching point SP. 4. "Cam high" (Switch cam high): Relay is switched off/inactive from right end position to the set switching point SP1, switched on/active between switching points SP1 and SP2 and switched off/inactive again after switching point SP2. Relay is switched off/inactive from left end position to the set switching point SP2, switched on/active between switching points SP2 and SP1 and switched off/inactive again after switching point SP1. 5. "Cam low" (Switch cam low): Relay is switched on/active from right end position to the set switching point SP1, switched off/inactive between switching points SP1 and SP2 and switched on/active again after switching point SP2. Relay is switched on/active from left end position to the set switching point SP2, switched off/inactive between switching points SP2 and SP1 and switched on/active again after switching point SP1. 6. "Bl.det.le" (Block detection left): Relay switches off when detecting a blockage in range of the left end position. Settable only on relays no. 3 & 4! 7. "Bl.det.ri" (Block detection right): Relay switches off when detecting a blockage in range of the right end position. Settable only on relays no. 3 & 4!
	<p style="text-align: center;">[1] Off</p> <p style="text-align: center;"><u>Relay switching state</u></p> <p>1 (switched on/active)</p> <p>0 (switched off/inactive)</p> <p style="text-align: center;"><i>left end position</i> <i>right end position</i></p>
	<p style="text-align: center;">[2] Sw.pt.high</p> <p style="text-align: center;"><u>Relay switching state</u></p> <p>1 (switched on/active)</p> <p>0 (switched off/inactive)</p> <p style="text-align: center;"><i>left end position</i> <i>SP</i> <i>right end position</i></p>

[3] Sw.pt.low

Relay switching state



[4] Cam high

Relay switching state

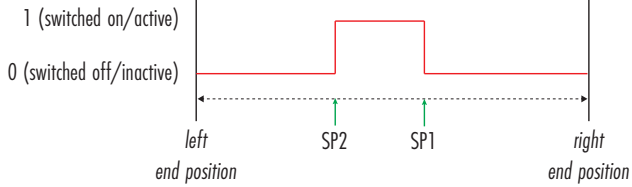

[5] Cam low

Relay switching state

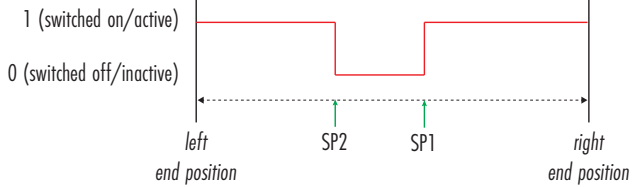

[6] Bl.det.le

Relay switching state

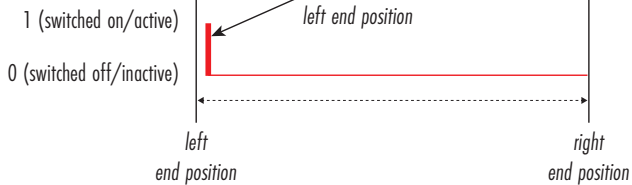

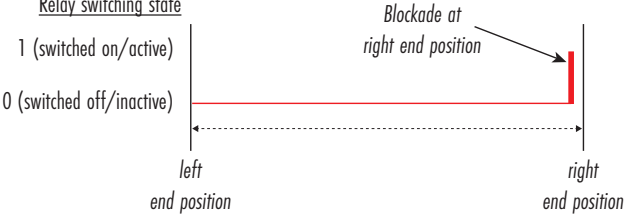

	<p style="text-align: center;">[7] Bl.det.ri</p> <p style="text-align: center;"><u>Relay switching state</u></p> <p>1 (switched on/active)</p> <p>0 (switched off/inactive)</p> 
	<p><u>Feedback of block detection via relay (Setting 6 & 7)</u></p> <p>The condition of the block detection can be put out via relay 3 and 4. Therefore, the settings for block detection are matched to the preferred relay in the relay settings menu. The block detection feedback can differ between block detection in left end position and block detection in right end position. On a block detection within the set range, the relay will switch.</p>

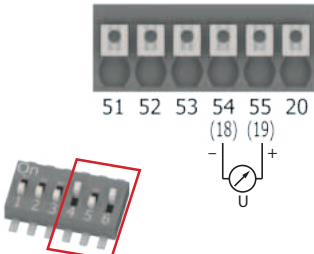
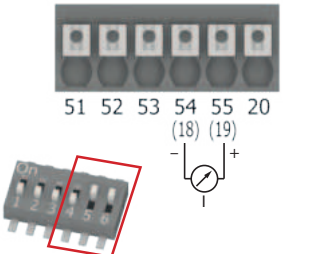
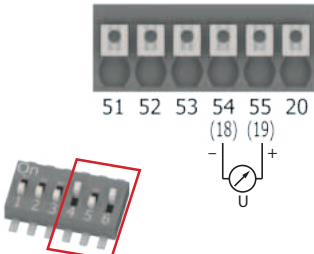
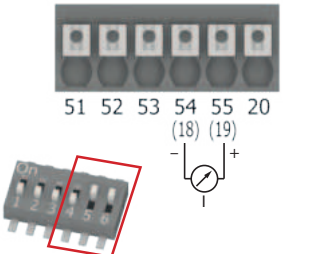
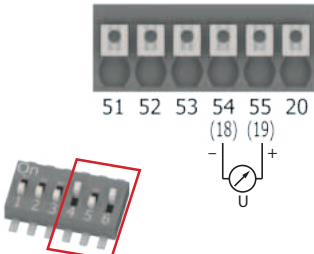
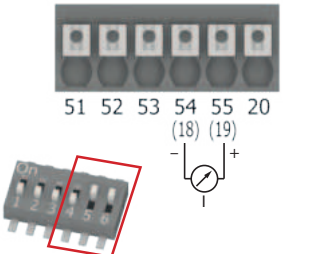
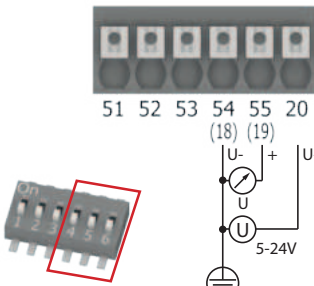
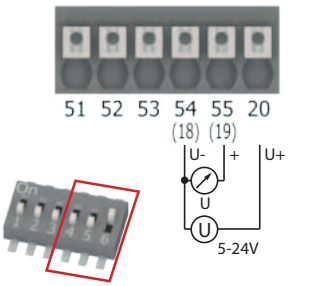
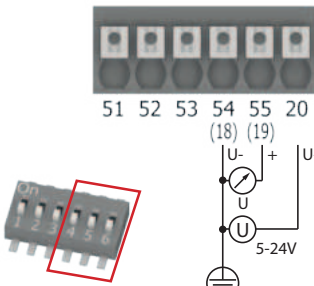
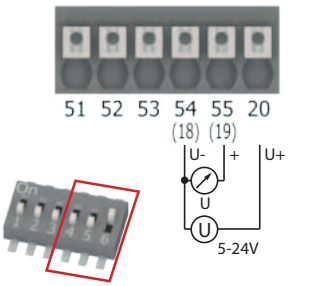
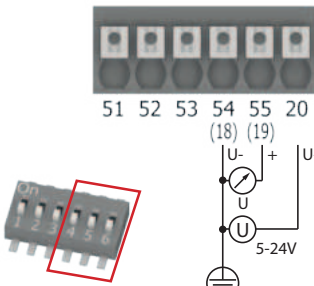
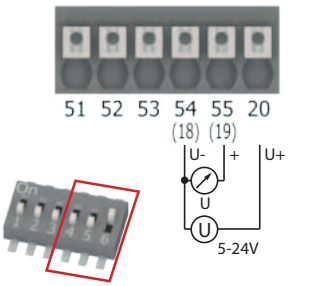

EXPT. MENU (Expert menu)

Signal IN	<i>Input signal</i>
	<p>Selection of input signal type for controlling the actuator.</p> <p>The following control features are available (depending on the activated features):</p> <ul style="list-style-type: none"> • Term. 2/3 (Terminal 2/3): Driving the actuator via terminal 2/3. • Ctrl. [mA] (Control [mA], iAct): Driving the actuator by feeding a set value signal in range 0...20 mA. • Ctrl. [V] (Control [V], iAct): Driving the actuator by feeding a set value signal in range 0...10 V. • Poti (Potentiometer, iAct): Driving the actuator via a connected external potentiometer.
	<div style="background-color: #000080; color: white; padding: 5px; display: inline-block;">! ADVICE</div> <p>The input signal type must additionally be set up with the onboard DIP switch, according to the desired signal type.</p> <p>DIP switch 1 and DIP switch 2 must not be active (On) simultaneous!</p> <p>DIP switch 4 and DIP switch 5 must not be active (On) simultaneous!</p>

Signal IN (Contd.)	<p><u>Settings of the DIP switch for input signals (DIP switches 1-3)</u> For the settings of the input signals use DIP switches 1-3. The position of DIP switches 4-6 is irrelevant to the input signal setting.</p>
i-Act	<p>Voltage input [V]</p> <div style="display: flex; justify-content: space-around;"> <div style="text-align: center;"> <p>Voltage source grounded</p> </div> <div style="text-align: center;"> <p>Voltage source potential-free</p> </div> </div>
i-Act	<p>Current input [mA]</p> <div style="display: flex; justify-content: space-around;"> <div style="text-align: center;"> <p>Current source grounded</p> </div> <div style="text-align: center;"> <p>Current source potential-free</p> </div> </div>
i-Act	<p>Potentiometer input</p> <p>When driving the actuator via a connected potentiometer, an auxiliary voltage of 5 V DC is generated over terminal 53 for poti supply. An additional external voltage supply for the potentiometer is not necessary.</p> <div style="text-align: center;"> <p>Potentiometer input</p> </div>

Signal OUT	Output signal		
	<p>Selection of the output signal type, used as position feedback. The following position feedbacks are available (depending on activated features):</p> <p>Feedback signal:</p> <ul style="list-style-type: none"> • Off: No feedback of actuator position. • Ctrl. [mA] (Control [mA], i-Act or current/voltage output): Output of an actual value signal [mA]. • Ctrl. [V] (Control [V], i-Act or current/voltage output): Output of an actual value signal [V]. • Poti (Potentiometer): Output of a voltage value of the internal electrical potentiometer, assigned to the actual actuator position. 		
	<p>! ADVICE</p> <p>The input signal type must additionally be set up with the onboard DIP switch, according to the desired signal type.</p> <p>DIP switch 1 and DIP switch 2 must not be active (On) simultaneous! DIP switch 4 and DIP switch 5 must not be active (On) simultaneous!</p>		
	<p><u>Settings of the DIP switch for output signals (DIP switches 4-6)</u></p> <p>For the settings of the output signals use DIP switches 4-6. The position of DIP switches 1-3 is irrelevant to the output signal setting.</p>		
i-Act Current/Voltage output	<table border="0" style="width: 100%;"> <tr> <td style="width: 50%; vertical-align: top;"> <p>Voltage output [V]</p> <p style="text-align: center;">Voltage output</p>  </td> <td style="width: 50%; vertical-align: top;"> <p>Current output [mA]</p> <p style="text-align: center;">Current output</p>  </td> </tr> </table>	<p>Voltage output [V]</p> <p style="text-align: center;">Voltage output</p> 	<p>Current output [mA]</p> <p style="text-align: center;">Current output</p> 
<p>Voltage output [V]</p> <p style="text-align: center;">Voltage output</p> 	<p>Current output [mA]</p> <p style="text-align: center;">Current output</p> 		
Potentiometer electrical	<table border="0" style="width: 100%;"> <tr> <td style="width: 50%; vertical-align: top;"> <p>Potentiometer output</p> <p style="text-align: center;">Potentiometer output Voltage source grounded</p>  </td> <td style="width: 50%; vertical-align: top;"> <p>Potentiometer output</p> <p style="text-align: center;">Potentiometer output Voltage source potential-free</p>  </td> </tr> </table>	<p>Potentiometer output</p> <p style="text-align: center;">Potentiometer output Voltage source grounded</p> 	<p>Potentiometer output</p> <p style="text-align: center;">Potentiometer output Voltage source potential-free</p> 
<p>Potentiometer output</p> <p style="text-align: center;">Potentiometer output Voltage source grounded</p> 	<p>Potentiometer output</p> <p style="text-align: center;">Potentiometer output Voltage source potential-free</p> 		

Signal OUT (Contd.)	<div style="background-color: #003366; color: white; padding: 5px; display: inline-block;">! ADVICE</div> <p>The terminal indication for the potentiometer output is different to prior Tensor electronics. The original terminal indications 18 and 19 were substituted by 54 and 55 (see wiring diagram).</p>												
Wire Monitor	Wire monitoring, formerly wire break monitoring												
	<p>Monitoring of the set value signal at the terminals when driving the actuator with set value signals (mA resp. V). The monitoring works only with preset values 4...20 mA resp. 2...10 V. In this range a set value signal <2 mA resp. <1 V is detected as an error and the error code 90 is displayed.</p>												
	<p>The following actuator behaviour can be set:</p> <table border="1" data-bbox="210 386 927 635"> <thead> <tr> <th>Setting</th> <th>Behaviour on missing/wrong set value signal</th> </tr> </thead> <tbody> <tr> <td>Off</td> <td>Monitoring deactivated</td> </tr> <tr> <td>Stop</td> <td>Actuator stops</td> </tr> <tr> <td>Open</td> <td>Actuator moves to OPEN position (turning direction of shaft CCW)</td> </tr> <tr> <td>Close</td> <td>Actuator moves to CLOSE position (turning direction of shaft CW)</td> </tr> <tr> <td>Position</td> <td>Actuator moves to a preset position</td> </tr> </tbody> </table>	Setting	Behaviour on missing/wrong set value signal	Off	Monitoring deactivated	Stop	Actuator stops	Open	Actuator moves to OPEN position (turning direction of shaft CCW)	Close	Actuator moves to CLOSE position (turning direction of shaft CW)	Position	Actuator moves to a preset position
Setting	Behaviour on missing/wrong set value signal												
Off	Monitoring deactivated												
Stop	Actuator stops												
Open	Actuator moves to OPEN position (turning direction of shaft CCW)												
Close	Actuator moves to CLOSE position (turning direction of shaft CW)												
Position	Actuator moves to a preset position												
	<p><u>Setting "Position"</u> Selecting the setting "Position" will show "<WP[actual position]%" in the display.</p> <ul style="list-style-type: none"> Pressing the buttons L & R, the actuator can be set to the desired position it should run to in case of a missing set value signal. Confirm desired position with the MENU button. Confirm (Y) or cancel (N) storing the position. Change between (Y)/(N) via buttons L & R, confirm selection with the MENU button. 												
Status Info	Message output												
	<p>The message output delivers the actual status of the actuator via a potential-free contact. The following settings are possible:</p> <ul style="list-style-type: none"> Off: Message output not active (no feedback over terminal 56 57) On: Message output active <p>When set to "On", the contact on terminal 56 57 is closed, while the actuator is in AUTO mode. The following events/conditions lead to an open contact:</p> <ul style="list-style-type: none"> Actuator in MANU mode Detection of a control variance (when active) Occurrence of an error 												
	<p><u>Performance data of the message output</u> Switching voltage: 250 V AC / 30 V DC Allowed continuous current: 3 A</p> <div style="text-align: right;">  </div>												

Offset	<i>Control variance</i>
	<p>Setting of the max. variance allowed between actual and set value of the controller (Standard variance). The allowed variance is stated in % depending on the set travel of the actuator. An override of the set max. variance will indicate an error at the message output (see "Status Info").</p> <p>Possible settings: 0 = Standard variance check deactivated 1...9% = Allowed standard variance in %</p> <p>Example: Menu setting = 2% Right end position 0% [0°] / Left end position 100% [90°]. A 90° travel corresponds to a max. allowed variance of 90° x 2% = 1.8°. The message output opens on a variance of the actual position from the set position of >1.8°.</p>
Hyst. stop	<i>Shut-off hysteresis</i>
	<p>The shut-off hysteresis defines the shut-off accuracy of the actuator when reaching the default set value position. The actual position of the actuator is checked against the set position and the default hysteresis value. The actuator stops if the actual position lies within the (shut-off) hysteresis range around the set value.</p> <p>The shut-off hysteresis of the actuator in control mode can be set in steps of 0.01% in a range of 0...5.00%.</p>
	<p> ADVICE</p> <p>The shut-off hysteresis has to be set lower than the turn-on hysteresis!</p> <p>If the hysteresis is set too low, the actuator may operate in an unwanted behaviour depending on the actuator type. In this case, the hysteresis must be increased.</p>
Hyst. start	<i>Turn-on hysteresis</i>
	<p>The turn-on hysteresis defines at which variance from the actual position to the set position the actuator will readjust. The actual position of the actuator is checked against the set position and the default hysteresis value. If the actual position of the actuator lies outside the (turn-on) hysteresis range around the set position, the actuator moves to the default set position.</p> <p>The turn-on hysteresis of the actuator in control mode can be set in steps of 0.01% in a range of 0...5.00%.</p>
	<p> ADVICE</p> <p>The turn-on hysteresis has to be set higher than the shut-off hysteresis!</p> <p>If the hysteresis is set too low, the actuator may operate in an unwanted behaviour depending on the actuator type. In this case, the hysteresis must be increased.</p>

Stall-Det.	<i>Stall detection</i>
	<p>The stall detection recognizes an accidental halt of the actuator and the BLDC motor, caused by a blockade. Subsequently the actuator stops to avoid damages to the actuator or the connected valve and an error code (Error Code 3X) is displayed.</p> <p>The error can be reset by driving the actuator in the opposite direction.</p>
Block-Det.	<i>Block detection in range of the end positions</i>
	<p>The block detection recognizes the run of the actuator against an intended block (e.g. valve seal, valve stop bar, etc.) within a settable range around the end positions and suppresses a stall error in this range.</p> <p>The capture range of the block detection is set in % from the right resp. left end position and can be set differently for both end positions.</p> <p>The following settings are possible: 0 = Block detection deactivated 1...10% = Capture range of block detection at an end position</p> <p>The block detection condition can be put out via the relays 3 and/or 4 (if applicable). See further information in section "Relay switch".</p> <p>If a block was detected, it will be interpreted as an end position. The display of the actuator's position (in %) stays unaffected from the block detection. On a block detection, reset the detection by driving the actuator in the opposite direction. The actuator turns off, if it reaches a default end position.</p> <p>Example: Menu setting: Block detection left/right = 2% When the actuator reaches the actual position <2% resp. >98% and detects a blockade in this range, the actuator stops on the blockade position. Relay 3 or 4 reacts depending on the equipment and setting of the actuator. No error will be displayed.</p>
RPM acc.	<i>Acceleration ramp</i>
	Defines the time [ms] of the acceleration ramp of the actuator in AUTO mode.
RPM red.	<i>Brake ramp</i>
	Defines the time [ms] of the brake ramp of the actuator in AUTO mode.

Add feature	<i>Adding features</i>
	<p>Enables the entry of an access code for activation of further actuator features. The following features can be activated by entering the access code:</p> <ul style="list-style-type: none"> • Potentiometer: Activation of the electrical potentiometer for position feedback • Current/Voltage output: Activation of the current/voltage output for position feedback • i-Act: Activation of the electrical potentiometer, the current/voltage output for position feedback and activation of the potentiometer input and the current/voltage input for controlling the actuator via set value signals ([mA] & [V]).
	<div style="background-color: #000080; color: white; padding: 5px; display: inline-block;">! ADVICE</div> <p>If you are interested in any additional feature, please contact the ARIS sales department and have the serial number of the mounted electronics ready (check INFO MENU "Serial-No.").</p>

POWR. MENU (Power menu)

Torque/Speed	<i>Torque/Actuating speed</i>
	<p>Enables the setting of pre-defined torque/time combinations. The setting of the torque/time combination can be made separately and differently for both turning directions "CCW" and "CW".</p>

INFO MENU (Information menu)

Firmware	Displays the firmware version of the electronics.
Hardware	Displays the version of the electronics hardware.
Serial-No.	<i>Serial number</i>
	<p>Displays the serial number of the actuator's electronics. The serial number of the electronics is used for the activation of additional actuator features and may be asked by the ARIS customer service.</p>
Features	<i>Functions/Features</i>
	<p>Shows active features/functions and further available features/functions of the actuator.</p> <p>The status of the different functions is marked as follows: Example for feature/function "POTI": Feature/Function activated: > POTI* Feature/Function not activated: > POTI</p>

On-time	<i>Operating hours counter</i>
	<p>Displays the overall operating hours of the actuator.</p> <p>The operating hours counter starts as soon as the actuator is supplied with power and stops when the power supply is cut off.</p> <p>The operating hours are stored even when a power failure occurs.</p> <p>A reset of the operating hours is not possible.</p>
Cycl. count	Cycle count
	<p>The cycle count counts the number of starts of the actuator in AUTO mode.</p> <p>The number of starts is stored even in case of a voltage cutoff.</p> <p>A reset of the counter is not possible.</p>
Modules	<i>Modules</i>
	<p>Displays (add-on) boards which are connected with the electronics.</p> <p>Connected and recognized boards are marked with an asterisk (*) after the board name.</p> <p>Example with relay board: Board connected/recognized: > Relay* Board not connected/not recognized: > Relay</p>
	<div style="background-color: #003366; color: white; padding: 5px; display: inline-block;">! ADVICE</div> <p>Add-on boards must only be mounted/dismounted when the electronics is de-energized!</p>

6.1.4 Handwheel

If the actuator is equipped with the "handwheel" option, it can be moved using the external handwheel when the power is off. To do this, press in the handwheel and then turn it by hand. When doing this, turn with particular care in the areas of the end positions of fittings, since high torques can be transmitted through the handwheel.

After the adjustment, the handwheel automatically disengages and jumps back to its original position. The handwheel does not turn during normal operation of the actuator.

 WARNING	Turning is only permitted by hand.
	The handwheel may only be used when the drive is de-energized (no voltage/no current).

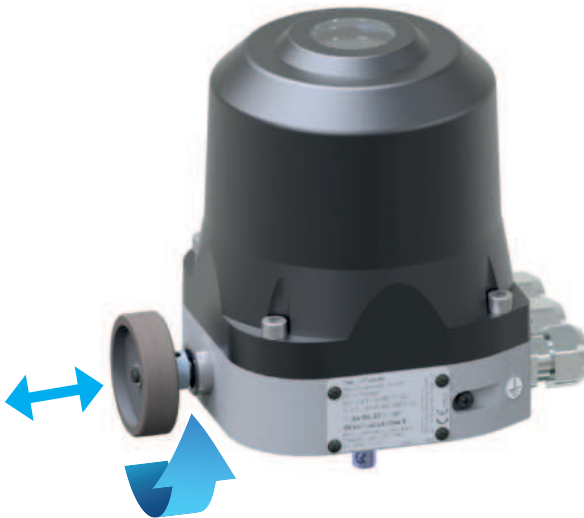

 WARNING	Danger! On the back of the drive, there is a blind plug to close the handwheel option for equipment variants without a handwheel. This may not be removed or altered.
---	---

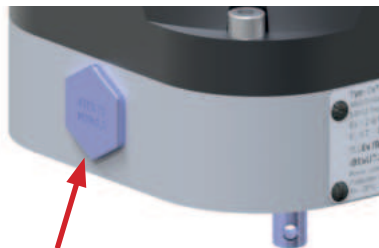

7. Options

more options - mechanical poti, terminals ... ?

8. Maintenance and service

ARIS actuators of the ExTensor series have permanent lubrication and are basically maintenance-free. We recommend carrying out a function test and a visual inspection once a year.

Repairs: No repairs or mechanical processing of any kind may be carried out on the gap surfaces of the flameproof gaps. In particular, the cover/housing gap surfaces must not be changed.



Non-observance can lead to serious accidents and damage to property - The ATEX/IECEx Approval for the device expires in the event of non-compliance or misuse.

Cleaning

Only clean the actuator with a damp cloth. Never clean with a high-pressure cleaner.



- Pressure proof encapsulation
- Before opening, ensure that there is no gas and no voltage
- Joint surfaces must not show any damage or contamination
- The hood must not tilt during assembly



Regular maintenance work:

- The type and scope of the tests correspond to the relevant national regulations (e.g. IEC/EN 60079-17).
- The deadlines are calculated in such a way that any defects that are to be expected be identified in a timely manner.

9. Declaration of incorporation



EC - Declaration of Conformity



Herewith we declare

Name:	ARIS Stellantriebe GmbH
Address:	Rotter Viehtrift 9, D - 53842 Troisdorf

in sole responsibility that the product

Designation:	Electric actuator
Series:	ExTensor and identical

to which this declaration refers, complies with the essential requirements of the following European directives by being in accordance with the specified harmonized standards:

Dir 2014/34/EU (ATEX)

EN IEC 60079-0:2018 (IEC 60079-0:2017, Ed. 7.0)

EN 60079-1:2014 (IEC 60079-1:2014, Ed. 7.0)

EN 60079-31:2014 (IEC 60079-31:2013, Ed. 2.0)

EN ISO/IEC 80079-34:2020

The actuators mentioned are group II and III devices in the sense of EN IEC 60079-0 and comply with the therein specified device protection levels

Gb, Group II, Subgroup IIC as well as Db, Group III, Subgroup IIC

In accordance with Directive 2014/34/EU, they meet the explosion protection requirements for Group II equipment and the following categories

2G in type of protection flameproof enclosure "db" for use in zone 1

2D in type of protection dust explosion protection by enclosure "tb" for use in zone 21

The explosion protection marking for the actuators of this series is as follows

⊕ II 2G Ex db IIC T6 Gb

⊕ II 2D Ex tb IIC T80 °C Db

Ta -20 °C ... +60 °C

The conformity assessment with regard to Dir 2014/34/EU has been confirmed by the type examination report IBExU22ATEX1066X / 0.

Dir 2011/65/EU

EN IEC 63000:2018

Dir 2014/30/EU

EN 61000-6-5:2015/AC:2018-01

The technical documentation has been fully created.

This declaration becomes invalid if the actuator is modified in any way that has not been approved by us or if the actuator is not used for the intended purpose.

Troisdorf 19.09.2023

i.V. R. Schulte (Quality and product safety)

10. Type examination certificate
(t.b.d.)

Subject to technical changes.

ARIS Stellantriebe GmbH
Rotter Viehtrift 9
53842 Troisdorf / Germany

Tel.: +49 2241 25186-0
Fax: +49 2241 25186-99
aris@stellantriebe.de

www.stellantriebe.de

